



savyonDIAGNOSTICS

member of the gamida diagnostics division

savvy•gen s

Respiratory Extraction Kit

REF 674-01; 677-01 96 extractions
675-01; 678-01 48 extractions

Store at 15°C - 35°C

For use with the Nextractor[®] NX-48S Instrument

For Research Use Only



Savyon® Diagnostics Ltd.

3 Habosem St. Ashdod 7761003

ISRAEL

Tel.: +(972).8.8562920

Fax: +(972).8.8523176

E-mail: support@savyondiagnosics.com

Table of Contents

Table of Contents

Introduction	3
Intended Use	3
Principle of Procedure	3
Materials & Equipment	4
Materials / Reagents Provided	4
Additional Equipment and Material Required	4
Kit Validity	4
Warnings & Precautions	4
Experimental Process	5
Experimental Methods	5
Sample collection & Storage	5
Test procedure	5
Troubleshooting	7

INTRODUCTION

Intended Use

The Savvygen™ S Respiratory Extraction Kit is an automatic extraction system for the isolation of high quality DNA/RNA from Plasma, Serum, Nasal swab, Throat swab, Nasopharyngeal swab, Sputum, CSF and UTM. This extraction kit is designed to use with Nextractor® NX-48S to provide high-yield and quality DNA/RNA from samples.

For Research Use Only.

Principle and procedure

The Savvygen™ Nucleic Acid Extraction technology is based on magnetic beads isolating the nucleic acid (NA) from Biological samples. The basic of this method is the use of Silica beads, capable of binding the NA in the presence of a chaotropic agent. This method is simple, rapid, and reliable method for the small-scale purification of NA from a Biological sample.

The Savvygen™ Extraction kit is designed to use with Nextractor® system, which offers fully automated extraction of up to 48 specimens at single run and within 16 minutes.

The Savvygen™ Extraction kit procedure is performed in the following steps:

- 1) The specimens are placed into the sample well plate, which contains in each well all the necessary reagents for the assay.
- 2) The well plate is placed on the loader tray of the Nextractor® system.
- 3) The user chooses the desired protocol and starts the program.

The extraction process for isolating nucleic acid from starting material by magnetic beads consists of the following 3 steps (Figure 1):

The first step of the extraction includes Lysis of the specimen in the presence of a large amount of chaotropic substance and Binding of releasing-Nucleic Acid to silica beads (magnetic bead).

The second step of extraction is washing silica beads. In this step, silica beads are washed in a washing solution several times to remove contaminants such as PCR inhibitors.

The third step of extraction is Nucleic Acid Elution. In this step, bonded nucleic acids are separated from the silica beads. Pure NA are eluted into buffer by decreasing the concentration of chaotropic substance

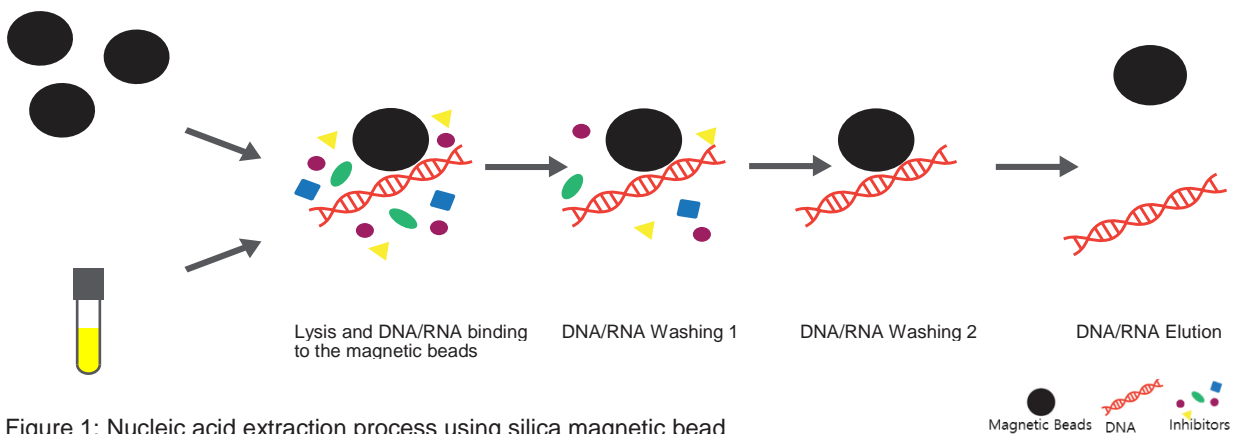

Figure 1: Nucleic acid extraction process using silica magnetic bead

MATERIALS & EQUIPMENT

Materials/ Reagents Provided

Product Description	Contents	Specimen type
Savvygen™ S Respiratory Extraction Kit REF#674-01; 96 extractions	Extraction Plate (Respiratory S) (96 well x 4 plates)	Plasma, Serum, Nasal swab, Throat swab, Nasopharyngeal swab, CSF and UTM.
	Rods Plastic Strip x 12 units	
Savvygen™ S Respiratory Extraction Kit REF#675-01; 48 extractions	Extraction Plate (Respiratory S) (32 well x 6 plates)	
	Rods Plastic Strip x 6 units	
Savvygen™ S Respiratory Extraction Kit REF#677-01; 96 extractions	Extraction Plate (Respiratory S) (96 well x 4 plates)	COVID -19 Nasopharyngeal Swab, Diluted Sputum
	Rods Plastic Strip x 12 units	
Savvygen™ S Respiratory Extraction Kit REF#678-01; 48 extractions	Extraction Plate ((Respiratory S) (32 well x 6 plates)	
	Rods Plastic Strip x 6 units	

Additional Equipment and Material Required

- Disposable powder-free gloves
- Appropriate volume pipettes
- Sterilized, filtered pipette tips
- Vortex mixer
- Tabletop centrifuge
- Nextractor® (NX-48S, Genolution Inc. KOREA). Distributed by Savvyon Diagnostics Ltd. Please refer to the instrument manual for more details.

Kit Validity



This kit is valid for 12 months when stored at 15-35°C.

WARNINGS & PRECAUTIONS

- All samples must be treated as potential biohazards. Wear appropriate protective eyewear, clothing, and gloves.
- Avoid direct skin contact with kit reagents. In case of contact, wash immediately and thoroughly with water.
- Minimize the inhalation of chemicals. Do not leave chemical containers open.
- All work should be conducted in properly equipped facilities for safety reason (i.e. physical containment devices).
- Individuals should be trained according to the relevant regulation and requirements of the company/institutions prior to working with potentially infectious materials.

The reagent well plates contain Ethanol and Chaotropic Salt. These substances should be considered flammable, harmful and irritants. The Savvygen™ S Respiratory Extraction Kit and reagent well plates are designed to be used with potentially infectious substances. Users should wear appropriate personal protective equipment (e.g. gloves and lab coat) when handling infectious substances.

Extraction Plate (Respiratory S)

	<p>Harmful – may cause sensitization skin contact. Avoid contact with skin, wear suitable gloves. Harmful to aquatic organizations may cause long-term adverse effects in aquatic environments. Contains: Chaotropic Salt</p>
	<p>Highly flammable– keep away from any source of ignition, no smoking Contains: Ethanol</p>

Do not use the product for any purpose other than its intended purpose.

EXPERIMENTAL PROCESS

Sample collection & Storage

Sample collection:

The Savvygen™ S Respiratory Extraction Kit is optimized™ for DNA/RNA extraction from various clinical samples as specified in the intended use. DNA/RNA should be isolated from the clinical sample within one day after collection.

Sample storage:

The clinical samples should be stored for 1 day at 2-8°C. For longer storage, the clinical samples should be kept at -20°C.

Experimental Methods

- The Savvygen™ S Respiratory Extraction Kit should be used with Nextractor® NX-48S system.
- All extractions should be processed at a temperature between 15-35°C.
- Our extraction kit should be kept at a temperature between 15-35°C. Otherwise, the result might be affected.
- Yellow discoloration of lysis buffer may be observed. However, this will not affect the extraction efficiency, when used under proper conditions and in their original packaging.

Note: if using the Savvygen S Respiratory Extraction kit (REF: 677-01, 678-01) for extraction of SARS-CoV-2 (COVID-19) from Sputum, please perform the following pre-treatment step:

- Add X1 PBS to make 1:1 proportion with Sputum sample. Vortex thoroughly until the sample is completely mixed and dissolved.
- Continue with the extraction process steps as described in the Test procedure

Test Procedure

1. Determine the number of samples to be tested and carefully remove the sealing film of the Respiratory Extraction Kit.

- Vortex the samples to mix and transfer 200µL of each sample into the sample wells (in a 96 wells plate: apply samples to the 1st, 5th, and 9th columns; in a 32 wells plate: apply samples to the 1st column) of the extraction plate (figure 2).

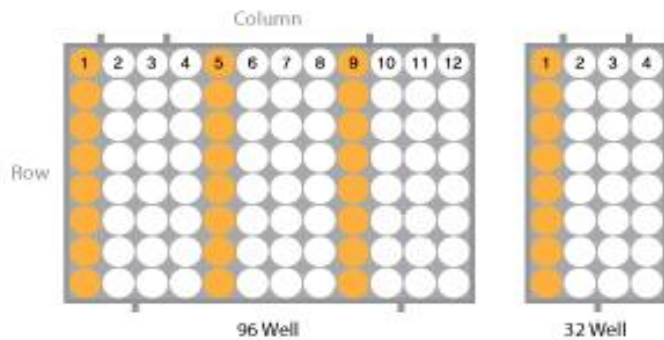

Figure 2: Samples wells (marked in orange) in respect to the Plate type

- Open the front glass door of the instrument and pull out the plate loader.
- Insert the rods plastic strip the strip holder in accordance to the tested samples plate and push it to the end (figure 3).

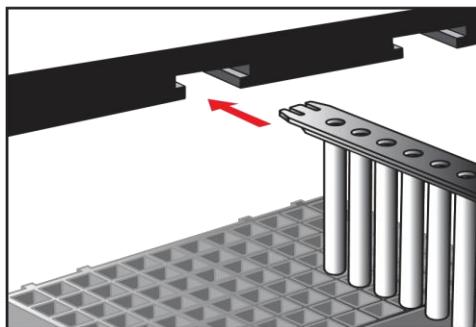

Figure 3: Inserting the rods plastic strip to its position

- Place the extraction plate on the plate loader. Note the plastic plates in their positions (Figure 4).

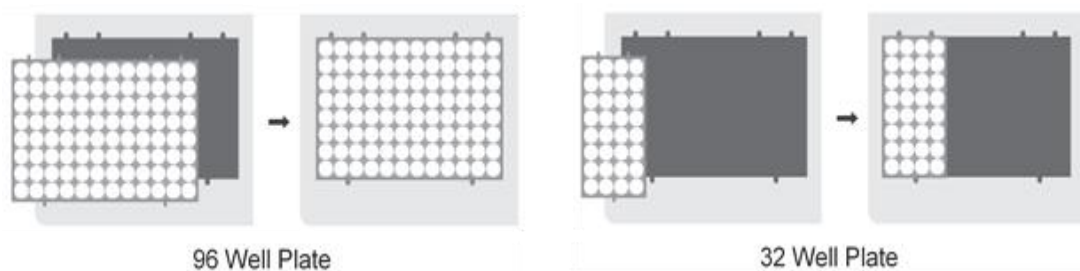

Figure 4: Positioning of the 96 or 32 wells plates on the plate loader

- Push the Plate Loader in until you hear a clicking sound and pull down the door to close.
- Select Extraction → Select Round Strip Type → Select Protocol → Select VN → Touch the On / OFF button to select the heating region for the left and right plate loader → Press the Set button to complete the setting → START (Figure 5)

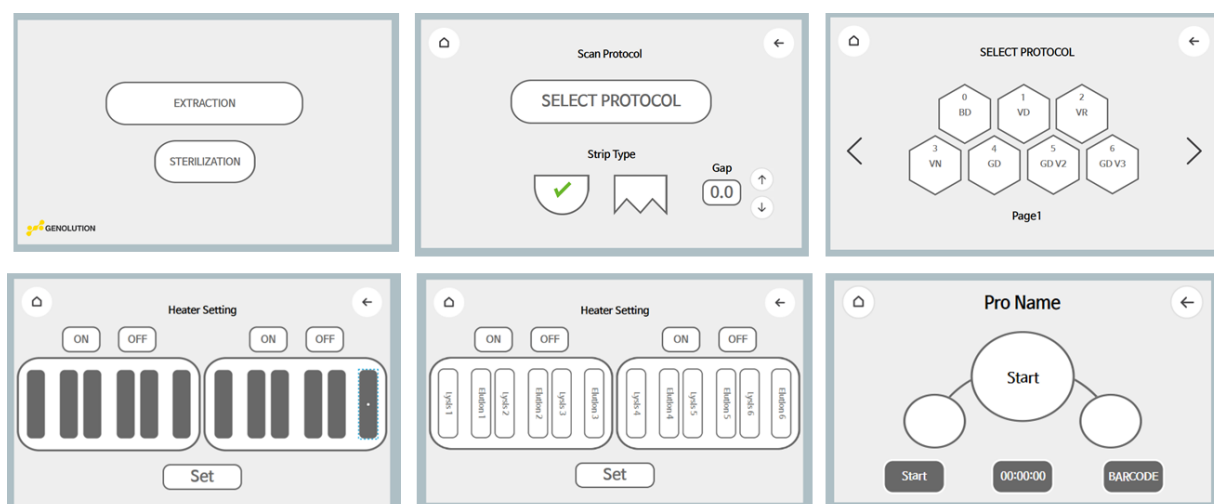

Figure 5: Protocol setting screens

Attention: When the Nextractor starts the extraction procedure, it should move the magnetic beads into the wells in the 1st column and mix them with the samples.

TROUBLESHOOTING









Symptoms	Causes	Solution
When running the extraction protocol the beads are not mixed with the sample in the 1 st column	Problem with the instrument calibration position	It is recommended to stop the run. Take out the sample plates from the instrument and turn off the power. Then turn on the instrument and start again the run protocol. If the problem reoccurs, please refer to the instrument manual for the instrument calibration
Considerable loss of elution buffer or no solution found in the well when extraction completed	Loss of magnetic beads and elution buffer due to excessive gDNA from specimen	It is recommended to reduce the volume of the specimen for extraction and return the run with a new plate
Excessive magnetic beads found in Elution well	Including impure material in the specimen	Place the well plate on separated magnetic plate, and use supernatant in the elution well when finished.
Poor amplification	Carryover Magnetic Beads may interfere with downstream amplification process.	Remove residue Magnetic Beads by using Magnet Bead Holder provided and use supernatant in the Elution Well.
Cross-contamination	Cross contamination due to user error	Use sterilized laboratory disposables for each sample to prevent sample-to-sample contamination. Avoid splashing when loading the sample into the sample well to minimize contamination of the adjacent wells.

For more information, please contact Savyon Diagnostics directly or your Distributor.

www.savyondx.com.

E-mail: info@savyondx.com

Explanation of Symbols

Symbols	Explanation	Symbols	Explanation
	Do not re-use		Please refer to the manual
	Lot Number		Expiration Date
	Catalog number		Manufacturer details
	Contents		Package contains sufficient for < n > tests